

General Description

The MIC862 is a dual low power operational amplifier in SOT23-8 package. It is designed to operate in the 2V to 5V range, rail-to-rail output, with input common-mode to ground. The MIC862 provides 3MHz gain-bandwidth product while consuming only a 31 μ A/Channel supply current.

With low supply voltage and SOT23-8 packaging, MIC862 provides two channels as general-purpose amplifiers for portable and battery-powered applications. Its package provides the maximum performance available while maintaining an extremely slim form factor. The minimal power consumption of this IC maximizes the battery life potential.

Features

- SOT23-8 packaging
- 3MHz gain-bandwidth product
- 5MHz, -3dB bandwidth
- 31 μ A supply current
- Rail-to-rail output
- Ground sensing at input (common mode to GND)
- Drive large capacitive loads
- Unity gain stable

Applications

- Portable equipment
- Medical Instrument
- PDAs
- Pagers
- Cordless phones
- Consumer electronics

Ordering Information

Part Number	Marking	Ambient Temp. Range	Package
MIC862BM8	A34	-40°C to +85°C	SOT23-8
MIC862YM8	<u>A</u> 34	-40°C to +85°C	SOT23-8 Pb-Free

Typical Application

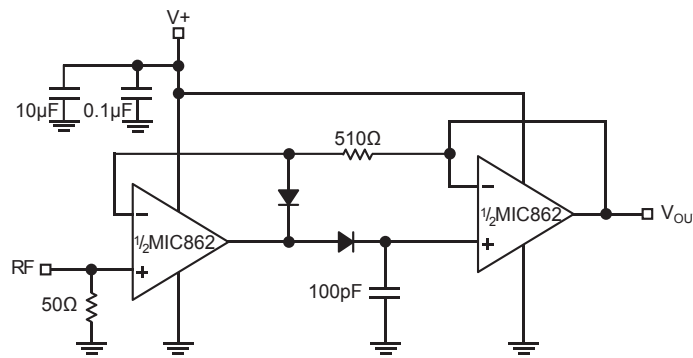

Peak Detector Circuit for AM Radio

Pin Configuration

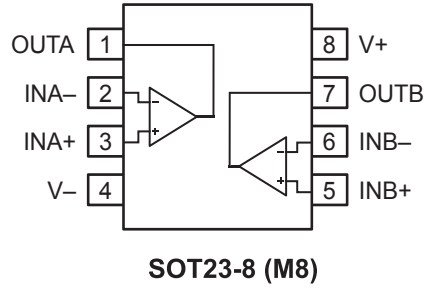

Pin Description

Pin Number	Pin Name	Pin Function
1	OUTA	Output: Amplifier A Output
2	INA-	Amplifier A Inverting (Input)
3	INA+	Amplifier A Non-Inverting (Input)
4	V-	Negative Supply
5	INB+	Amplifier B Non-Inverting (Input)
6	INB-	Amplifier B Inverting (Input)
7	OUTB	Output: Amplifier B Output
8	V+	Positive Supply

Absolute Maximum Ratings⁽¹⁾

Supply Voltage ($V_{V+} - V_{V-}$).....	+6.0V
Differential Input Voltage ($ V_{IN+} - V_{IN-} $), Note 4	+6.0V
Input Voltage ($V_{IN+} - V_{IN-}$)	$V_{V+} + 0.3V, V_{V-} - 0.3V$
Lead Temperature (soldering, 5 sec.).....	260°C
Output Short Circuit Current Duration	Indefinite
Operating Temperature.....	-40°C to +125°C
Storage Temperature (T_S)	150°C
ESD Rating, Note 3	

Operating Ratings⁽²⁾

Supply Voltage ($V_{V+} - V_{V-}$)	+2V to +5.25V
Ambient Temperature Range.....	-40°C to +85°C
Package Thermal Resistance.....	PCB boards
θ_{JA} (using 4 layer PCB)	100°C/W
θ_{JC} (using 4 layer PCB)	70°C/W

Electrical Characteristics

$V_{V+} = +2V, V_{V-} = 0V, V_{CM} = V_{V+}/2; R_L = 500k\Omega$ to $V_{V+}/2; T_A = 25^\circ C$, unless otherwise noted. **Bold** values indicate $-40^\circ C \leq T_A \leq +85^\circ C$.

Symbol	Parameter	Condition	Min	Typ	Max	Units
V_{OS}	Input Offset Voltage		-6 -5	0.1	6 5	mV
	Differential Offset Voltage			0.5		mV
	Input Offset Voltage Temp Coefficient			6		$\mu V/^\circ C$
I_B	Input Bias Current			10		pA
I_{OS}	Input Offset Current			5		pA
V_{CM}	Input Voltage Range (from V_{V-})	CMRR > 50dB	0.5	1		V
CMRR	Common-Mode Rejection Ratio	$0 < V_{CM} < 1V$	45	75		dB
PSRR	Power Supply Rejection Ratio	Supply voltage change of 2V to 2.7V	50	78		dB
A_{VOL}	Large-Signal Voltage Gain	$R_L = 5k\Omega, V_{OUT} = 1.4V_{P-P}$	66	74		dB
		$R_L = 100k\Omega, V_{OUT} = 1.4V_{P-P}$	75	89		dB
		$R_L = 500k\Omega, V_{OUT} = 1.4V_{P-P}$	85	100		dB
V_{OUT}	Maximum Output Voltage Swing	$R_L = 5k\Omega$	V+80mV	V+55mV		V
		$R_L = 500k\Omega$	V+3mV	V+1.4mV		V
V_{OUT}	Minimum Output Voltage Swing	$R_L = 5k\Omega$		V-14mV	V+20mV	mV
		$R_L = 500k\Omega$		V+0.85mV	V+3mV	mV
GBW	Gain-Bandwidth Product	$R_L = 20k\Omega, C_L = 2pF, A_v = 11$		2.1		MHz
PM	Phase Margin	$R_L = 20k\Omega, C_L = 2pF, A_v = 11$		57		°
BW	-3dB Bandwidth	$R_L = 1M\Omega, C_L = 2pF, A_v = 1$		4.2		MHz
SR	Slew Rate	$R_L = 1M\Omega, C_L = 2pF, A_v = 1$, Positive Slew Rate = 1.5V/ μs		2		V/ μs
I_{SC}	Short-Circuit Output Current	Source	1.8	2.6		mA
		Sink	1.5	2.2		mA
I_S	Supply Current (per op amp)	No Load		27	43	μA
	Channel-to-Channel Crosstalk	Note 5		-100		dB

$V_{V+} = +2.7V, V_{V-} = 0V, V_{CM} = V_{V+}/2; R_L = 500k\Omega$ to $V_{V+}/2; T_A = 25^\circ C$, unless otherwise noted. **Bold** values indicate $-40^\circ C \leq T_A \leq +85^\circ C$.

V_{OS}	Input Offset Voltage		-6 -5	0.1	6 5	mV
	Differential Offset Voltage			0.5		mV
	Input Offset Voltage Temp Coefficient			6		$\mu V/^\circ C$
I_B	Input Bias Current			10		pA
I_{OS}	Input Offset Current			5		pA
V_{CM}	Input Voltage Range	CMRR > 60dB	1	1.8		V
CMRR	Common-Mode Rejection Ratio	$0 < V_{CM} < 1.35V$	65	83		dB

Symbol	Parameter	Condition	Min	Typ	Max	Units
PSRR	Power Supply Rejection Ratio	Supply voltage change of 2.7V to 3V	60	85		dB
A_{VOL}	Large-Signal Voltage Gain	$R_L = 5k\Omega, V_{OUT} = 2V_{P-P}$	65	77		dB
		$R_L = 100k\Omega, V_{OUT} = 2V_{P-P}$	80	90		dB
		$R_L = 500k\Omega, V_{OUT} = 2V_{P-P}$	90	101		dB
GBW	Gain-Bandwidth Product	$R_L = 20k\Omega, C_L = 2pF, A_v = 11$		2.3		MHz
PM	Phase Margin	$R_L = 20k\Omega, C_L = 2pF, A_v = 11$		50		°
BW	-3 dB Bandwidth	$R_L = 1M\Omega, C_L = 2pF, A_v = 1$		4.2		MHz
SR	Slew Rate	$R_L = 1M\Omega, C_L = 2pF, A_v = 1$ Positive Slew Rate 1.5V/ μ s		3		V/ μ s
I_{SC}	Short-Circuit Output Current	Source	4.5	6.3		mA
		Sink	4.5	6.2		mA
I_S	Supply Current (per op amp)	No Load		28	45	μ A
	Channel-to-Channel Crosstalk	Note 5		-120		dB

$V_{+} = +5V, V_{-} = 0V, V_{CM} = V_{+}/2; R_L = 500k\Omega$ to $V_{+}/2; T_A = 25^{\circ}C$, unless otherwise noted. **Bold** values indicate $-40^{\circ}C \leq T_A \leq +85^{\circ}C$.

V_{OS}	Input Offset Voltage		-6 -5	0.1	6 5	mV
	Differential Offset Voltage			0.5		mV
	Input Offset Voltage Temp Coefficient			6		μ V/ $^{\circ}C$
I_B	Input Bias Current			10		pA
I_{OS}	Input Offset Current			5		pA
V_{CM}	Input Voltage Range (from V_{-})	CMRR > 60dB	3.5	4.1		V
CMRR	Common-Mode Rejection Ratio	$0 < V_{CM} < 3.5V$,	60	87		dB
PSRR	Power Supply Rejection Ratio	Supply voltage change from 3V to 5V	60	92		dB
A_{VOL}	Large-Signal Voltage Gain	$R_L = 5k\Omega, V_{OUT} = 4.8V_{P-P}$	65	73		dB
		$R_L = 100k\Omega, V_{OUT} = 4.8V_{P-P}$	80	86		dB
		$R_L = 500k\Omega, V_{OUT} = 4.8V_{P-P}$	89	96		dB
V_{OUT}	Maximum Output Voltage Swing	$R_L = 5k\Omega$	V+-50mV	V+-37mV		V
		$R_L = 500k\Omega$	V+-3mV	V+-1.3mV		V
V_{OUT}	Minimum Output Voltage Swing	$R_L = 5k\Omega$		V-+24mV	V-+ 40mV	mV
		$R_L = 500k\Omega$		V-+0.7mV	V-+ 3mV	mV
GBW	Gain-Bandwidth Product	$R_L = 20k\Omega, C_L = 2pF, A_v = 11$		3		MHz
PM	Phase Margin			45		°
BW	-3 dB Bandwidth	$R_L = 1M\Omega, C_L = 2pF, A_v = 1$		5		MHz
SR	Slew Rate	$R_L = 1M\Omega, C_L = 2pF, A_v = 1$ Positive Slew Rate 1.8V/ μ s		4		V/ μ s
I_{SC}	Short-Circuit Output Current	Source	17	23		mA
		Sink	18	27		mA
I_S	Supply Current (per op amp)	No Load		31	47	μ A
	Channel-to-Channel Crosstalk	Note 5		-120		dB

Note 1. Exceeding the absolute maximum rating may damage the device.

Note 2. The device is not guaranteed to function outside its operating rating.

Note 3. Devices are ESD sensitive. Handling precautions recommended. Human body model, 1.5k in series with 100pF. Pin 4 is ESD sensitive

Note 4. Exceeding the maximum differential input voltage will damage the input stage and degrade performance (in particular, input bias current is likely to increase).

Note 5. DC signal referenced to input. Refer to Typical Characteristics graphs for AC performance.

Typical Characteristics

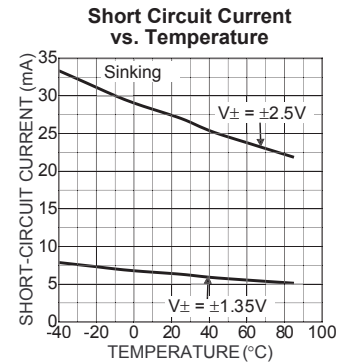
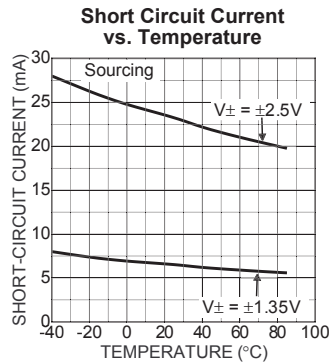
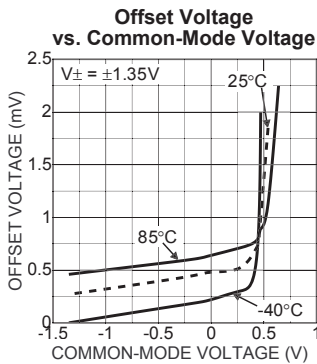
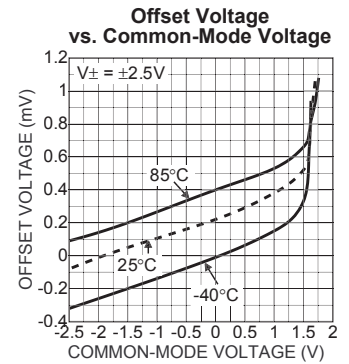
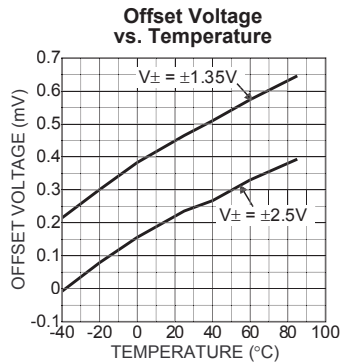
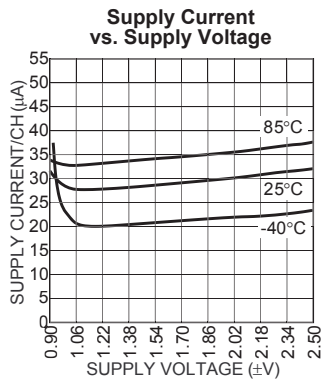
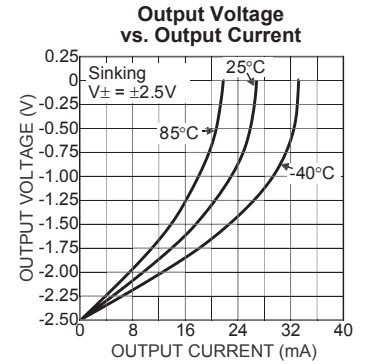
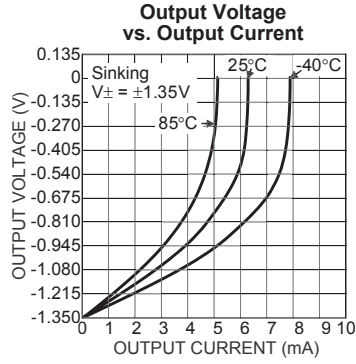
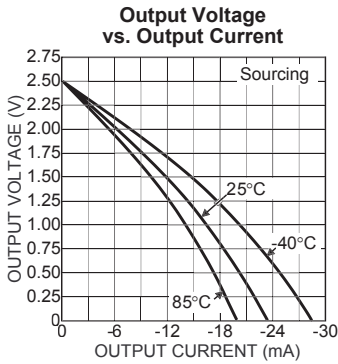
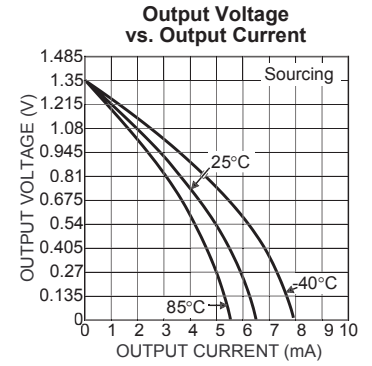
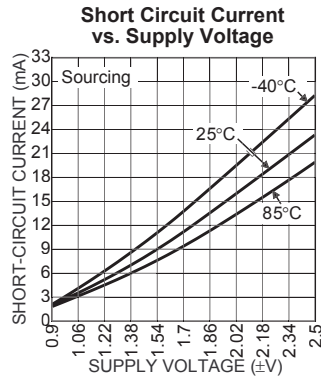
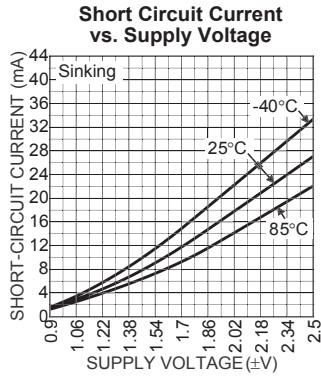

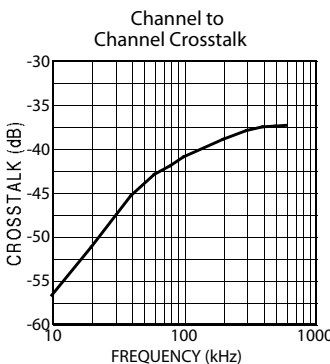
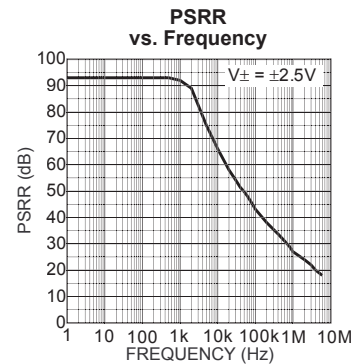
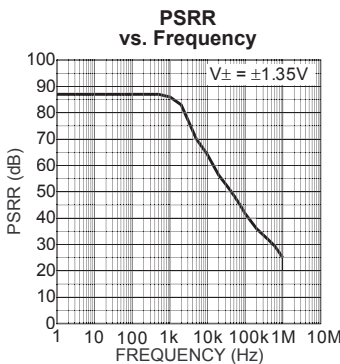
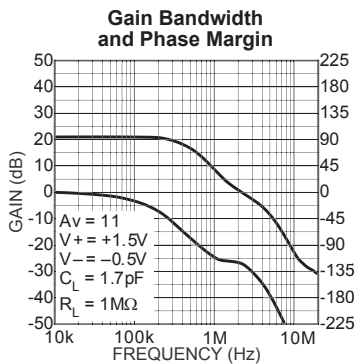
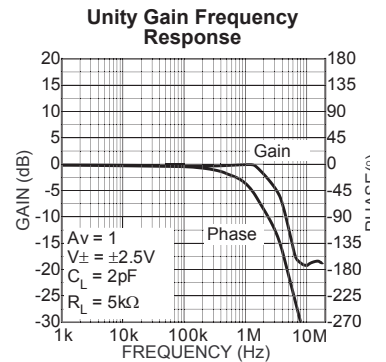
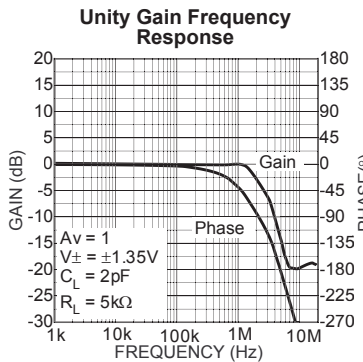
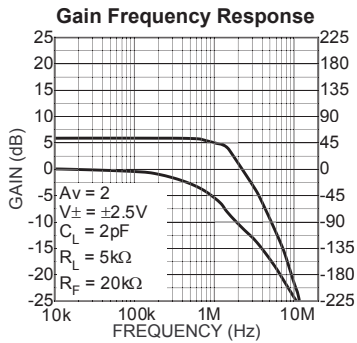
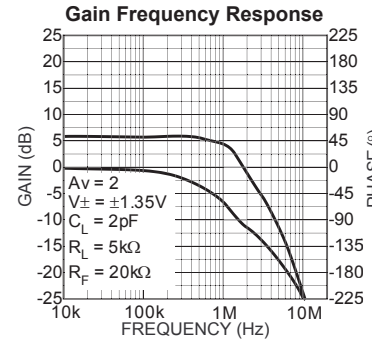
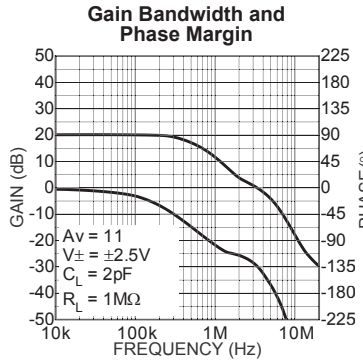
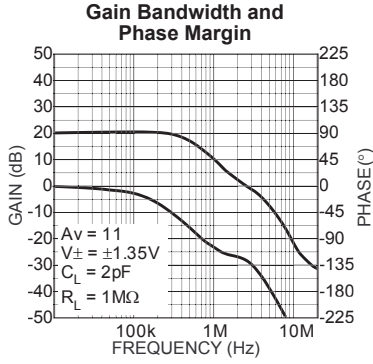

Functional Characteristics

Small Signal Response

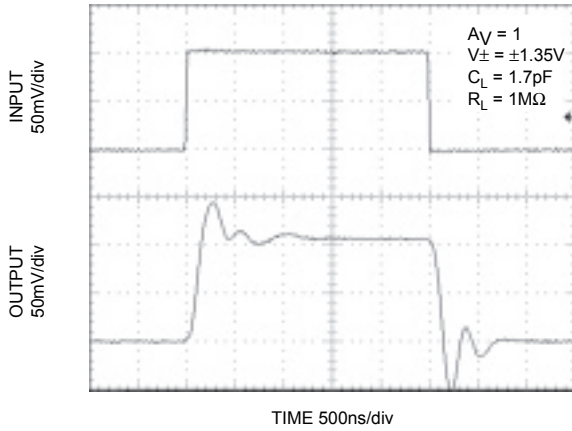

Small Signal Response

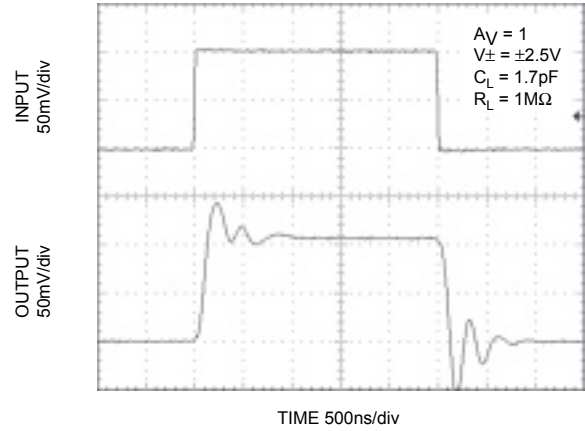

Small Signal Response

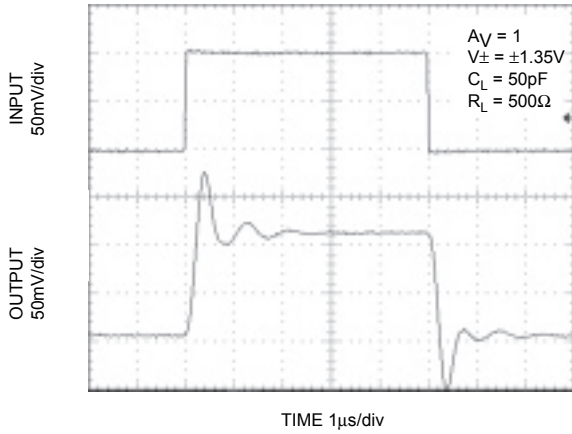

Small Signal Response

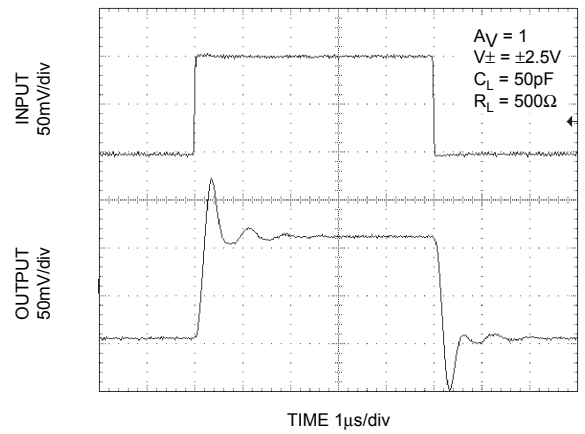

Small Signal Response

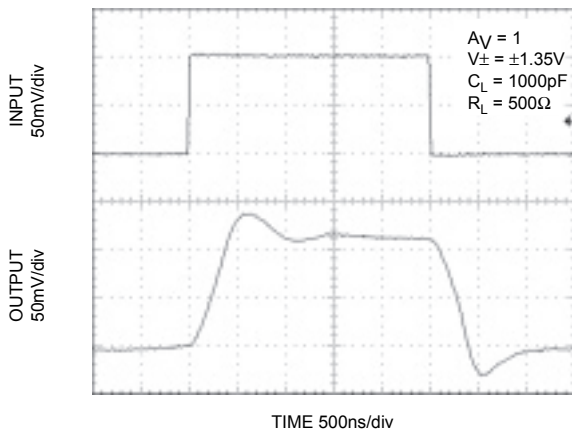

Small Signal Response

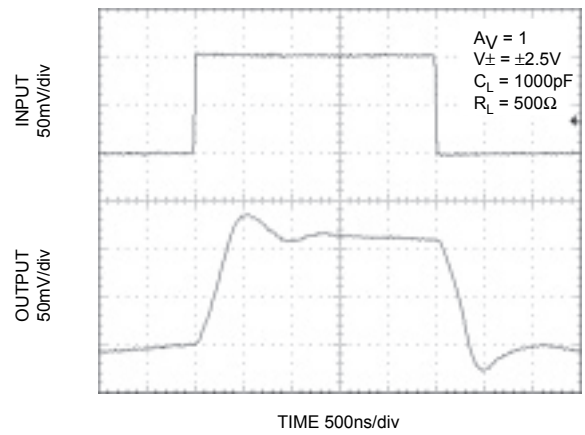

Small Signal Pulse Response

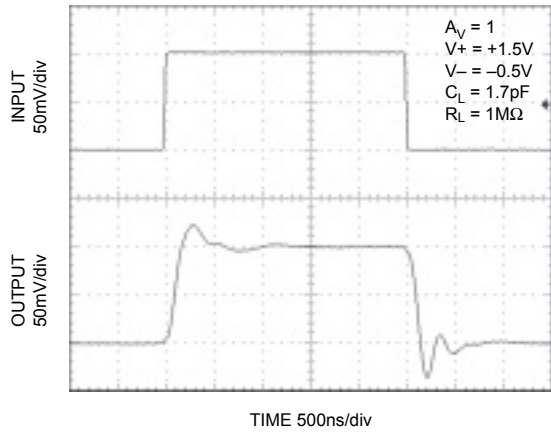

Large Signal Response

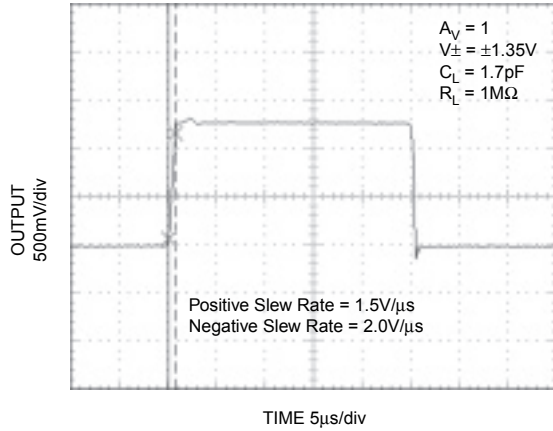

Large Signal Response

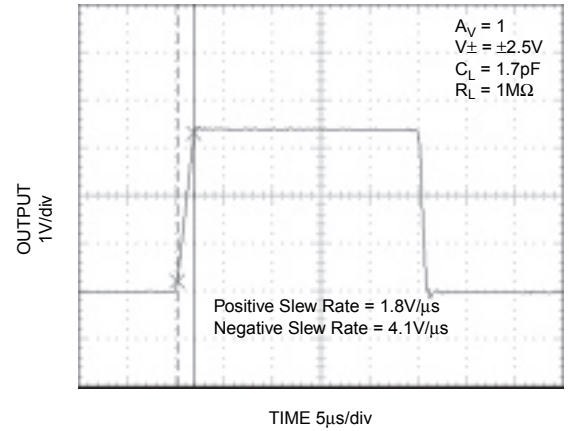

Large Signal Response

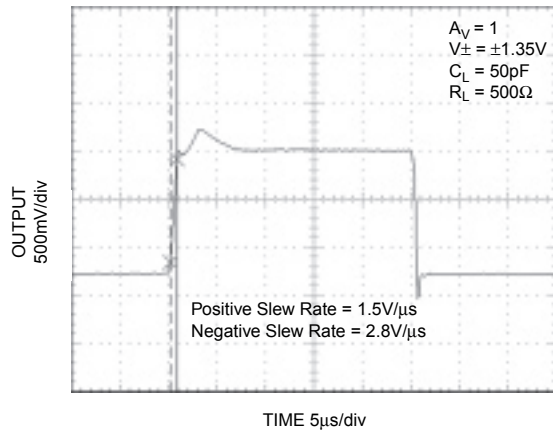

Large Signal Response

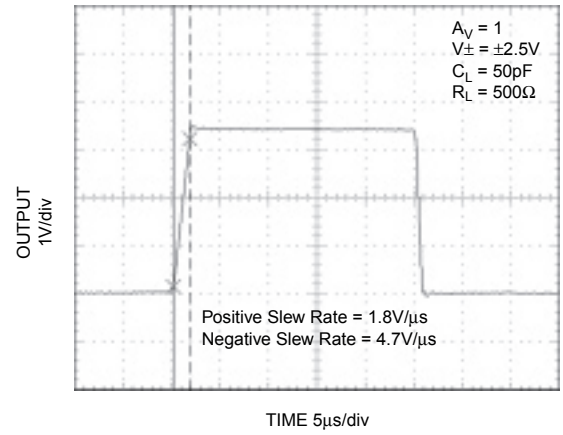

Large Signal Pulse Response

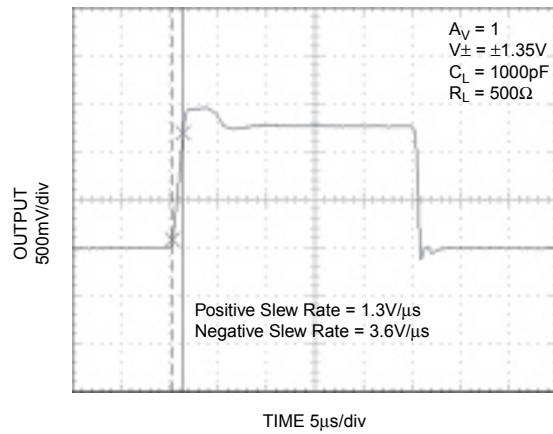

Large Signal Pulse Response

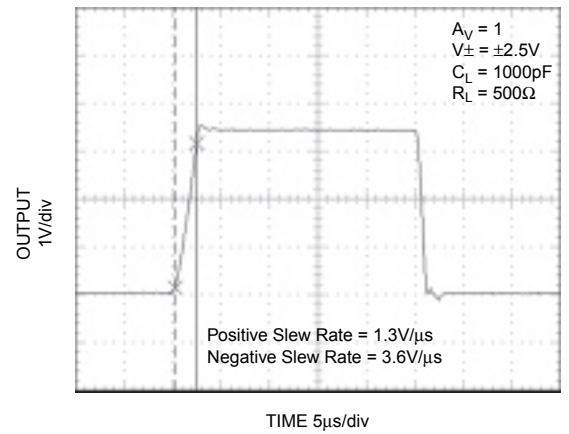

Large Signal Pulse Response

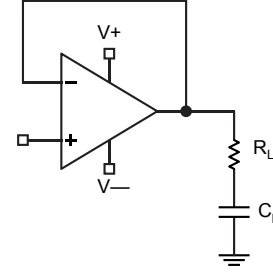
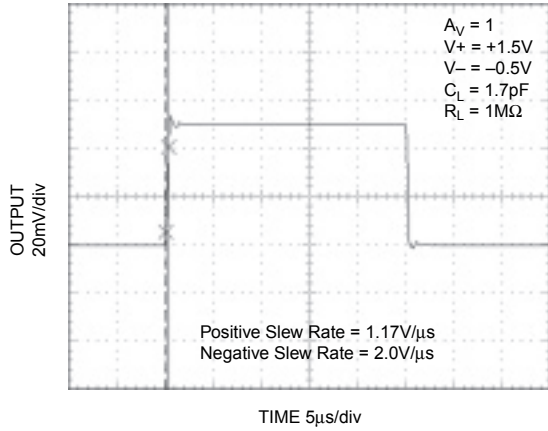

Rail to Rail Operation

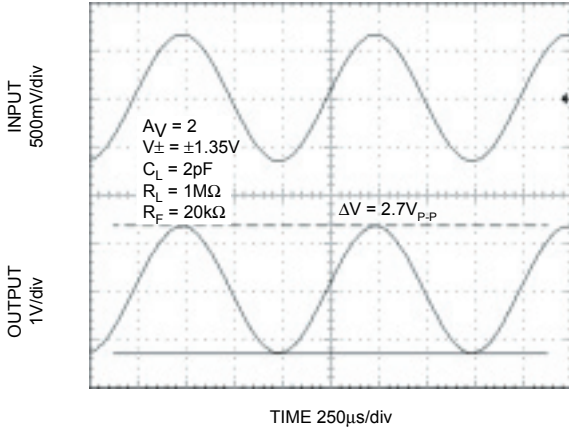

Rail to Rail Operation

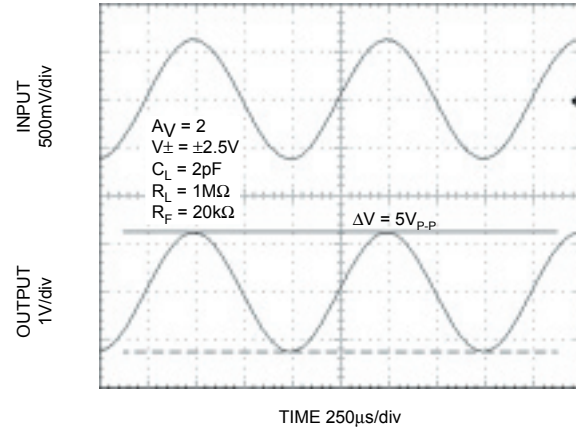

Rail to Rail Operation

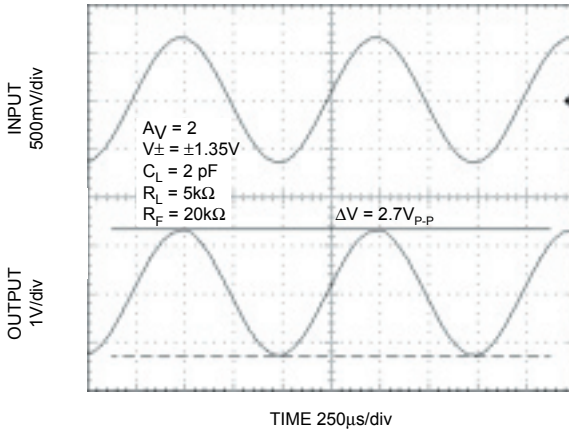

Rail to Rail Operation

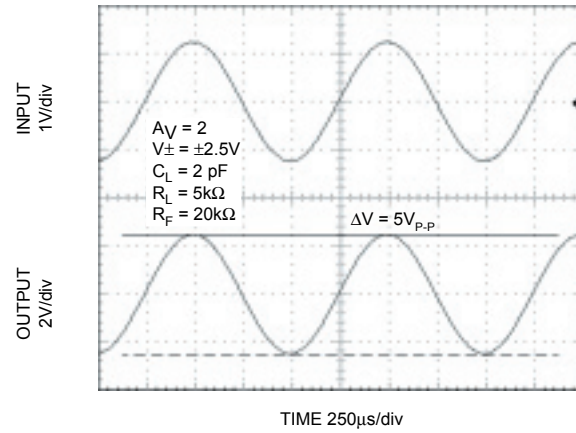

Applications Information

Power Supply Bypassing

Regular supply bypassing techniques are recommended. A 10 μ F capacitor in parallel with a 0.1 μ F capacitor on both the positive and negative supplies are ideal. For best performance all bypassing capacitors should be located as close to the op amp as possible and all capacitors should be low ESL (equivalent series inductance), ESR (equivalent series resistance). Surface-mount ceramic capacitors are ideal.

Supply and Loading Resistive Considerations

The MIC862 is intended for single supply applications configured with a grounded load. It is not advisable to operate the MIC862 under either of the following conditions:

1. A grounded load and split supplies (+/-V)
2. A single supply where the load is terminated above ground.

Under the above conditions, if the load is less than 20kOhm and the output swing is greater than 1V(peak), there may be some instability when the output is sinking current.

Capacitive Load

When driving a large capacitive load, a resistor of 500 Ω is recommended to be connected between the op-amp output and the capacitive load to avoid oscillation.

Package Information

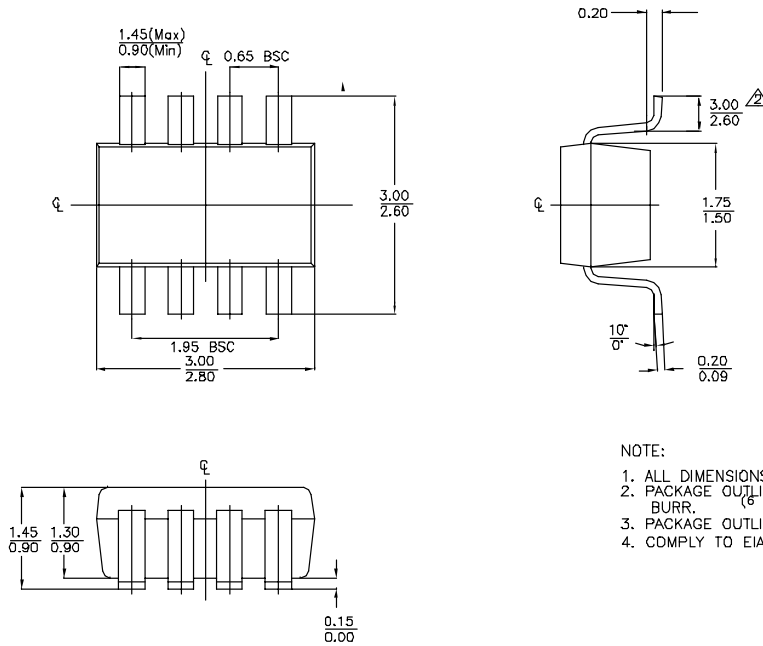

NOTE:

1. ALL DIMENSIONS ARE IN MILLIMETERS.
2. PACKAGE OUTLINE EXCLUSIVE OF MOLD FLASH & METAL BURR. (6 LEAD VERSION)
3. PACKAGE OUTLINE INCLUSIVE OF SOLDER PLATING.
4. COMPLY TO EIAJ SC74

SOT-23-8 (M8)

MICREL, INC. 2180 FORTUNE DRIVE SAN JOSE, CA 95131 USA

TEL + 1 (408) 944-0800 FAX + 1 (408) 474-1000 WEB <http://www.micrel.com>

The information furnished by Micrel in this data sheet is believed to be accurate and reliable. However, no responsibility is assumed by Micrel for its use. Micrel reserves the right to change circuitry and specifications at any time without notification to the customer.

Micrel Products are not designed or authorized for use as components in life support appliances, devices or systems where malfunction of a product can reasonably be expected to result in personal injury. Life support devices or systems are devices or systems that (a) are intended for surgical implant into the body or (b) support or sustain life, and whose failure to perform can be reasonably expected to result in a significant injury to the user. A Purchaser's use or sale of Micrel Products for use in life support appliances, devices or systems is at Purchaser's own risk and Purchaser agrees to fully indemnify Micrel for any damages resulting from such use or sale.

© 2004 Micrel, Incorporated.